

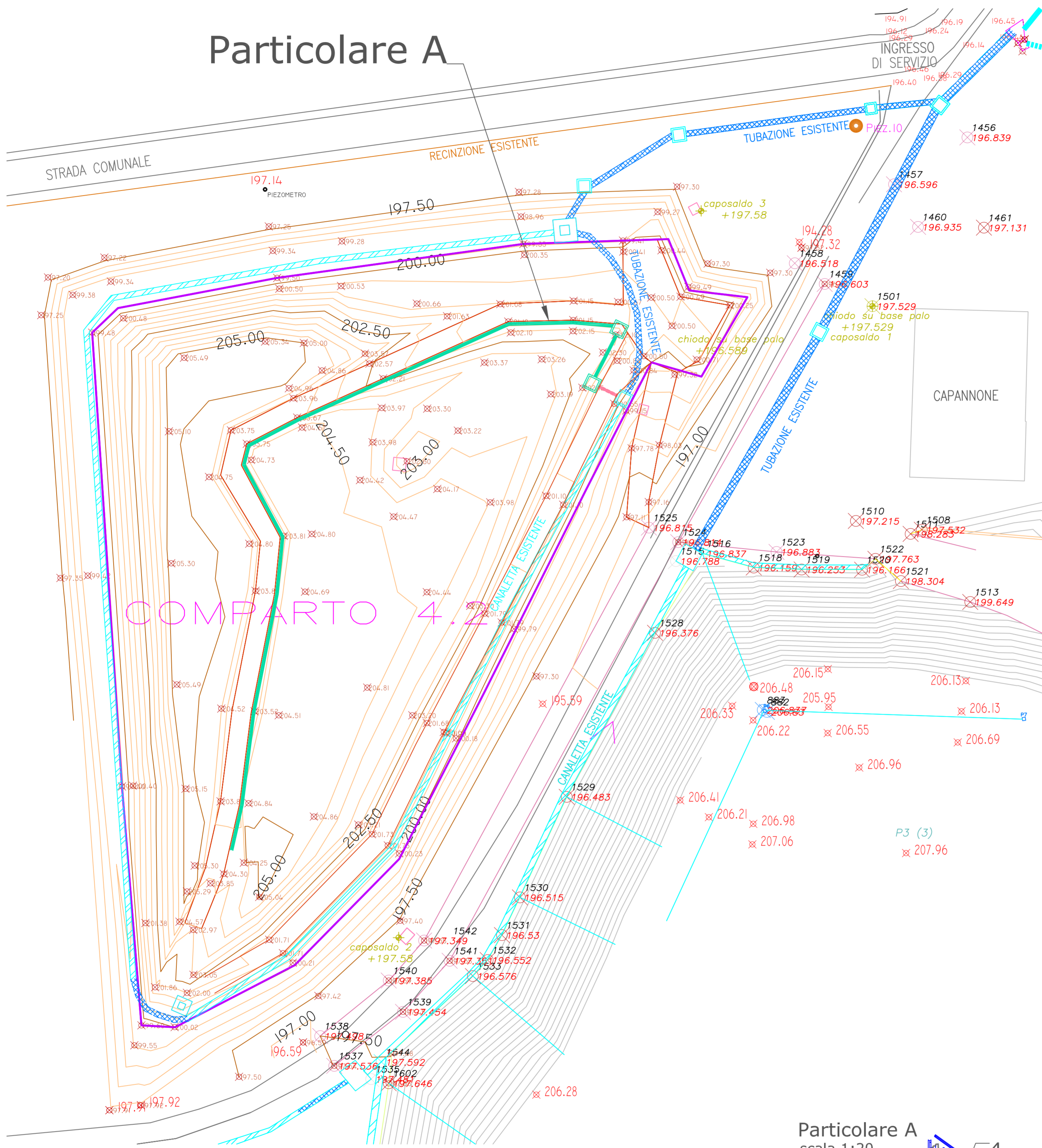







# Particolare A



-  Canalette e tubazioni esistenti
-  Nuova canaletta di raccolta delle acque meteoriche in acciaio zincato, Ø 0,5 m
-  Pozzetti in calcestruzzo, 1x1x1 m
-  Tubazione sottopasso strada in PEAD PE 100 PN 10, De 200 mm
-  Contorno dell'area di intervento
-  Quote finali a copertura completa
-  Quote invariate

scala 1:500

Particolare A  
scala 1:20

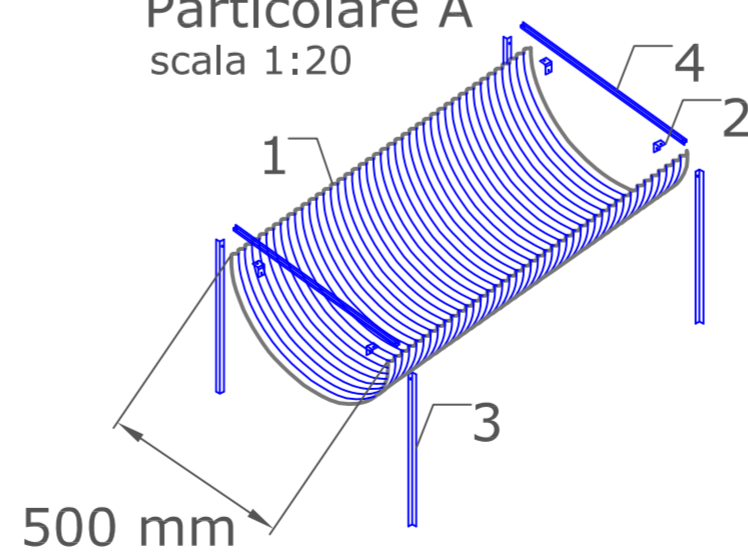

Spessore mm 2,7  
(30 kg/ml compreso  
angolare e bulloneria)

- 1 canaletta
- 2 supporto
- 3 piede
- 4 staffa

Regione Piemonte



Strada vecchia per Bosco Marengo - Novi Ligure

Provincia di Alessandria

POTENZIAMENTO DISCARICA CONTROLLATA  
PER RIFIUTI SOLIDI NON PERICOLOSI  
IN NOVI LIGURE

Sistemazione finale comparti 4.1 e 4.2

Progetto esecutivo

GRUPPO DI LAVORO:

**STUDIO TECNICO ASSOCIATO**  
Ing. Sandro Teruggi - Ing. Fausto Borgini  
Geom. Carlo D. Amabile - Geom. Angelo P. Baldi  
Ing. Simone Moscardini - Geom. Antonino Buglisi  
Geom. Bianca Musatti  
Via Marelli, 32 - 15033 Casale M. (AL)  
Tel. 0142 451515 - Fax 0142 590023  
ingsta@tin.it



Rev.	Data	REDAZIONE	APPROVAZIONE	AUTORIZZAZIONE
00	06/13	N. Buglisi	A. Baldi	F. Borgini

Regimazione delle acque  
meteoriche - Comparto 4.2

Elab. n.	D.4
Scala	varia
Data	giugno 2011
File n.	11S08